

## Block of the Month - November 2009

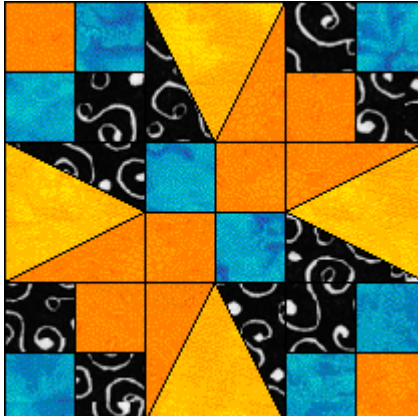

### Block 3 - Bird of Paradise

This 12" block can be constructed using several techniques. You can make this block using rotary cutting methods for the squares and paper piecing for the star points or if you prefer you can construct your block using templates. You'll find all the instructions and templates for all of these methods on the following pages.

Use your own color palette or follow the one shown. Note that this block has the same shapes as Block 1. The difference between the two is the color placement.

All seams are 1/4".

#### IMPORTANT - PLEASE READ

Please note that not all printers work the same. You should check the measurement of your printed templates. Sometimes a computer/printer system will resize the printout and your measurements won't be accurate.

The printed paper piecing templates (page 2) should measure 4 1/2" square, this includes the seam allowances. If you don't get this measurement when you measure, you can easily draw your own paper piecing pattern. Draw a 4" square. Along one side, find the half way point, which is 2". Make a small mark. Align a ruler at this mark and mark a line down to each corner that is on the opposite side of the block. Now draw in your 1/4" seam allowance. You will need four of these.

For the templates that aren't paper pieced (page 3), the square should measure 2 1/2" square. If it doesn't, then you know your printer has resized them and they won't be accurate. You can check to see if your printer has any settings that will print them at original size, but if you don't have that option you should then use the rotary cutting and paper piecing methods.

#### Rotary cutting the squares

From orange fabric - cut six 2 1/2" squares

From black fabric - cut six 2 1/2" squares

From turquoise fabric - cut eight 2 1/2" squares

Make two units as shown in diagram 1.

Make two units as shown in diagram 2.

Make one unit as shown in diagram 3.

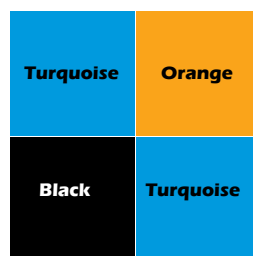

diagram 1

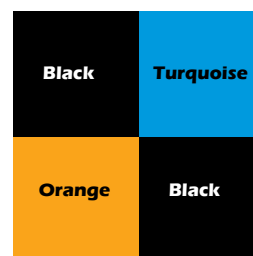

diagram 2



diagram 3

Paper piecing the star points. Make two copies of this page so that you have a total of four paper pieced units like those shown at right. Using the paper piecing method, create your star points.

Note that the orange and black fabrics are switched from the top paper piece unit to the bottom unit. You will need two of each unit.

Combine the completed star points with the square units from page 1 to finish your quilt block.

The block will finish to 12½" square.

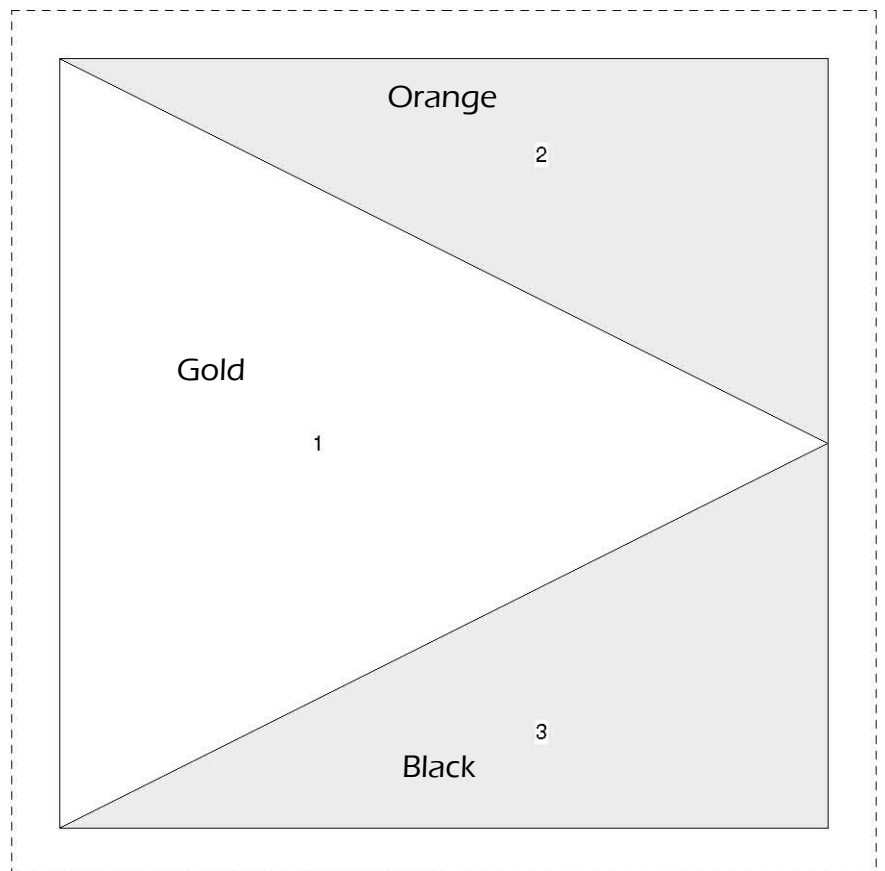
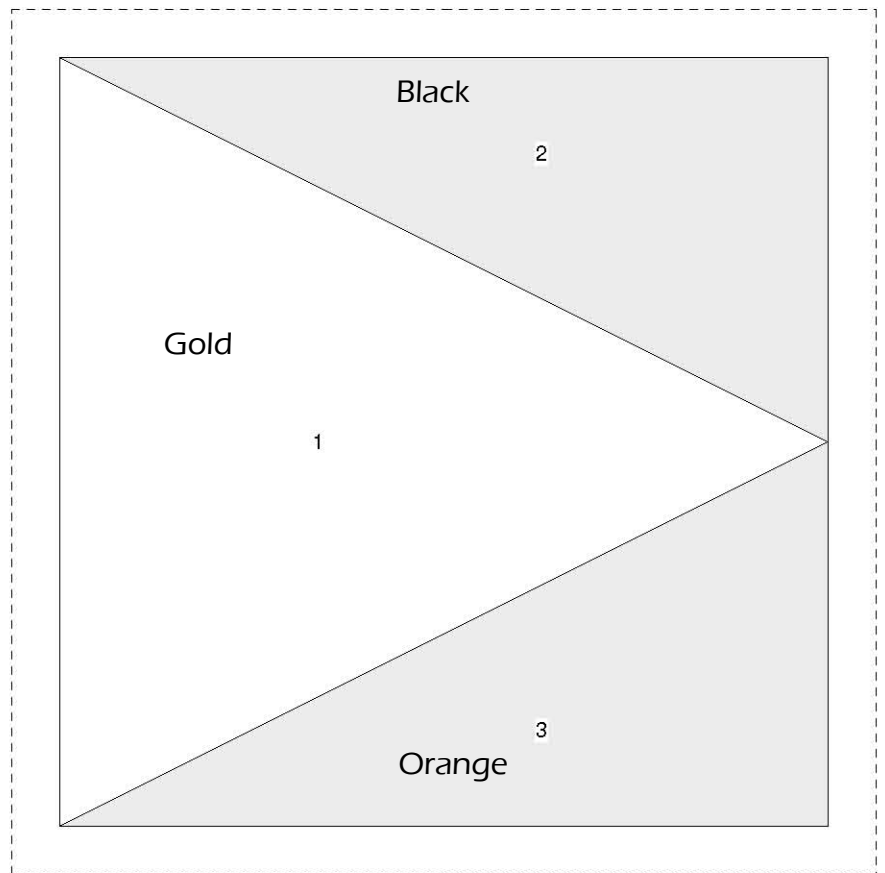

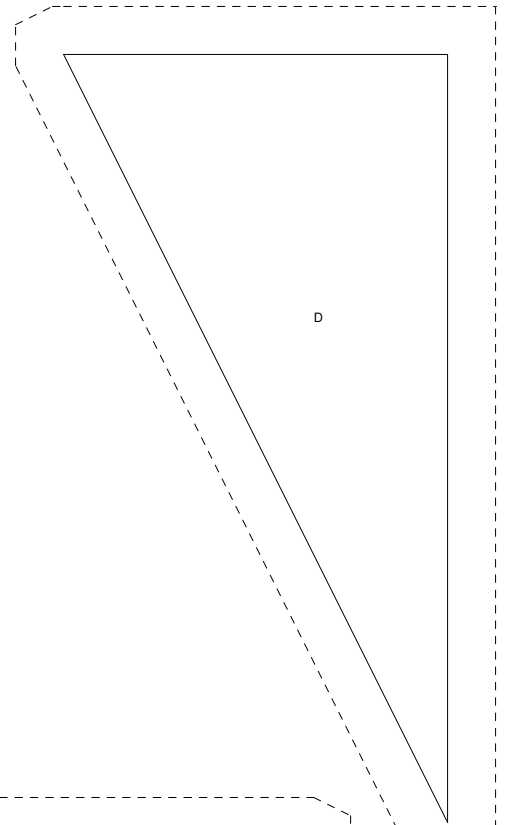
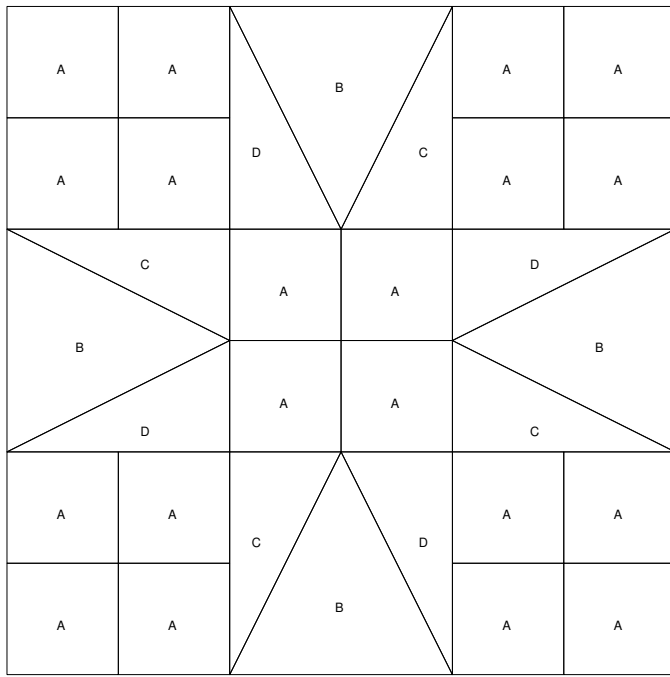

Use these templates if you prefer to piece your quilt block using a template method.

